

## Grüne Serie • Green Series • Série verte

für Modelle der heutigen Generation:  
for machines of the current generation:  
pour machines de la génération actuelle:

**Peddibasic No. 1**  
**Peddicat No. 1**  
**Peddiworker No. 1**

**Hydraulic 280**  
**Hydraulic 502**  
**Hydraulic 801**

für ältere Modelle:  
for older machine types:  
pour modèles plus anciens:

**Peddicat 361 • 380 • 500**  
**Peddiworker 501 • 502 • 801 • 802 • 1000 G**  
**Peddimaster 100/160 • 110/170 • 800/1100 • 1100/1700**  
**Peddimax 600 • 601 • 602 • 800 • 801 • 1002 • 110/140**  
**Hydraulic 100 • 301 • 501 • 800 • 1000 • 1001**  
**210 Super 16 • 20, 210 Standard 16**  
**Forax 80 • 100 • 1000**  
**225 B/16 • 20 • 80 • 100**  
**225 H/15 • 20**

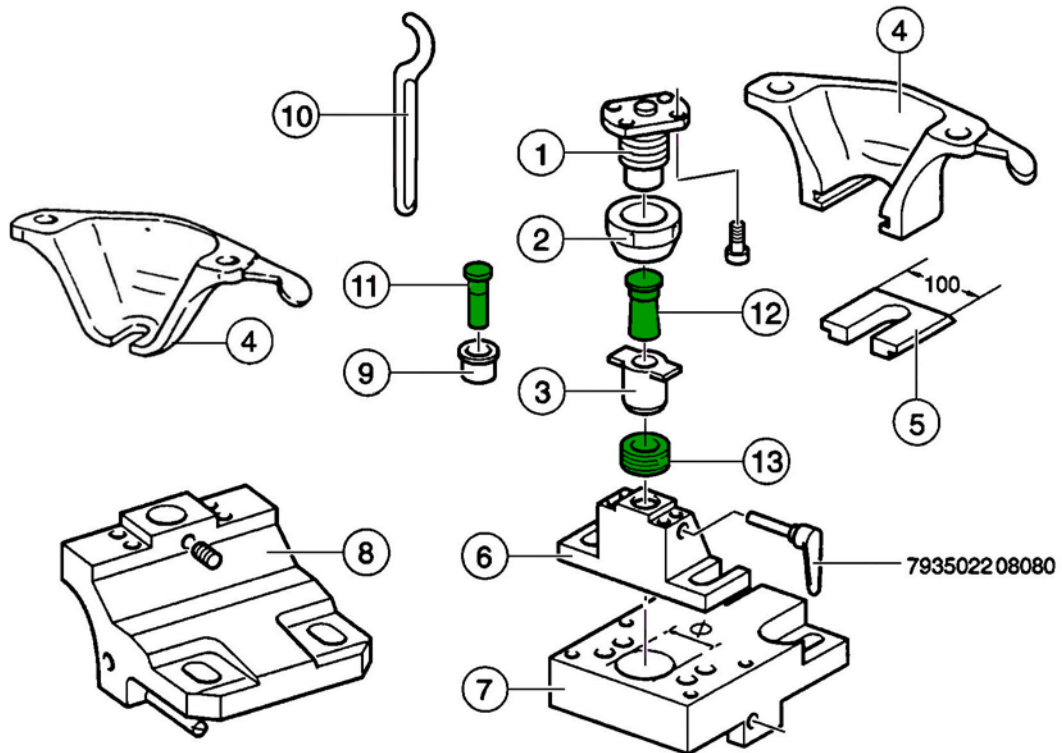

Stempel und Matrizen zur Schnellwechsellvorrichtung  
Punches and dies for the quick-change punching attachment  
Poinçons et matrices pour utilisation dans le dispositif de serrage rapide du poinçon

**Grüne Serie • Green Series • Série verte**

**Rundstempel**  
 round punch  
 poinçon rond

**Rundstempel**  
 round punch  
 poinçon rond

**Rundmatrize**  
 round die  
 matrice ronde

**Rundmatrize**  
 round die  
 matrice ronde

**Winkelstahlmatrize**  
 offset flat die  
 matrice ronde décentrée

**Nr. 2      Nr. 5      Nr. 3      Nr. 3      Nr. 14**

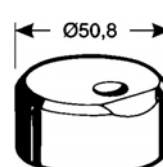
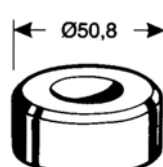
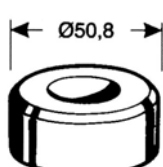
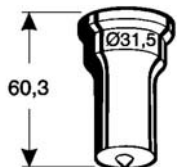
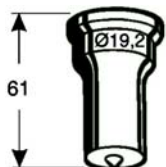

	Artikel-Nr.		Artikel-Nr.		Artikel-Nr.		Artikel-Nr.		Artikel-Nr.
3,0	64002 1030	17,5	64005 1175	3,2	64203 1032	20,2	64203 1202	5,7	64214 1057
3,2	64002 1032	18,0	64005 1180	3,4	64203 1034	20,7	64203 1207	6,2	64214 1062
3,5	64002 1035	18,5	64005 1185	3,7	64203 1037	21,2	64203 1212	6,7	64214 1067
4,0	64002 1040	19,0	64005 1190	4,2	64203 1042	21,7	64203 1217	7,2	64214 1072
4,2	64002 1042	19,5	64005 1195	4,4	64203 1044	22,2	64203 1222	7,7	64214 1077
4,5	64002 1045	20,0	64005 1200	4,7	64203 1047	22,7	64203 1227	8,2	64214 1082
5,0	64002 1050	20,5	64005 1205	5,2	64203 1052	23,2	64203 1232	8,7	64214 1087
5,5	64002 1055	21,0	64005 1210	5,7	64203 1057	23,7	64203 1237	9,2	64214 1092
6,0	64002 1060	21,5	64005 1215	6,2	64203 1062	24,2	64203 1242	9,7	64214 1097
6,5	64002 1065	22,0	64005 1220	6,7	64203 1067	24,7	64203 1247	10,2	64214 1102
7,0	64002 1070	22,5	64005 1225	7,2	64203 1072	25,2	64203 1252	10,7	64214 1107
7,5	64002 1075	23,0	64005 1230	7,7	64203 1077	25,7	64203 1257	11,2	64214 1112
8,0	64002 1080	23,5	64005 1235	8,2	64203 1082	26,2	64203 1262	11,7	64214 1117
8,5	64002 1085	24,0	64005 1240	8,7	64203 1087	26,7	64203 1267	12,2	64214 1122
9,0	64002 1090	24,5	64005 1245	9,2	64203 1092	27,2	64203 1272	12,7	64214 1127
9,5	64002 1095	25,0	64005 1250	9,7	64203 1097	27,7	64203 1277	13,2	64214 1132
10,0	64002 1100	25,5	64005 1255	10,2	64203 1102	28,2	64203 1282	13,7	64214 1137
10,5	64002 1105	26,0	64005 1260	10,7	64203 1107	28,7	64203 1287	14,2	64214 1142
11,0	64002 1110	26,5	64005 1265	11,2	64203 1112	29,2	64203 1292	14,7	64214 1147
11,5	64002 1115	27,0	64005 1270	11,7	64203 1117	29,7	64203 1297	15,2	64214 1152
12,0	64002 1120	27,5	64005 1275	12,2	64203 1122	30,2	64203 1302	15,7	64214 1157
12,5	64002 1125	28,0	64005 1280	12,7	64203 1127	30,7	64203 1307	16,2	64214 1162
13,0	64002 1130	28,5	64005 1285	13,2	64203 1132	31,2	64203 1312	16,7	64214 1167
13,5	64002 1135	29,0	64005 1290	13,7	64203 1137	31,7	64203 1317	17,2	64214 1172
14,0	64002 1140	29,5	64005 1295	14,2	64203 1142	32,2	64203 1322	17,7	64214 1177
14,5	64002 1145	30,0	64005 1300	14,7	64203 1147	32,7	64203 1327	18,2	64214 1182
15,0	64002 1150	30,5	64005 1305	15,2	64203 1152	33,2	64203 1332	18,7	64214 1187
15,5	64002 1155	31,0	64005 1310	15,7	64203 1157			19,2	64214 1192
16,0	64002 1160	31,5	64005 1315	16,2	64203 1162			19,7	64214 1197
16,5	64002 1165	32,0	64005 1320	16,7	64203 1167			20,2	64214 1202
17,0	64002 1170			17,2	64203 1172			20,7	64214 1207
17,5	64002 1175			17,7	64203 1177			21,2	64214 1212
18,0	64002 1180			18,2	64203 1182			21,7	64214 1217
18,5	64002 1185			18,7	64203 1187			22,2	64214 1222
19,0	64002 1190			19,2	64203 1192			22,7	64214 1227
				19,7	64203 1197			23,2	64214 1232
								23,7	64214 1237
								24,2	64214 1242
								24,7	64214 1247



Reduzierhülse 2 / 5  
 reducing sleeve  
 réducteur

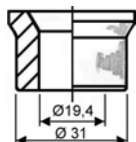

44081 198 503

Schneidspiel: Seite  
 clearance: see page  
 jeu: voir page  
 71



Streichmaß: Seite  
 back marks: see page  
 trusquinage: voir page  
 73

## Grüne Serie • Green Series • Série verte

**Vierkantstempel**  
 square punch  
 poinçon carré

**Vierkantmatrize**  
 square die  
 matrice carrée

**Langlochstempel**  
 oblong punch  
 poinçon oblong

**Langlochmatrize**  
 oblong die  
 matrice oblongue





### Nr. 2

### Nr. 3

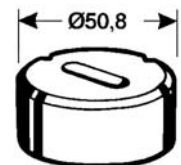
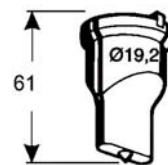
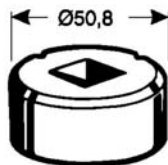
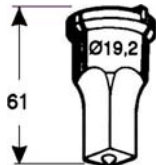
### Nr. 2

### Nr. 3



Vierkantstempel		Vierkantmatrize		Langlochstempel		Langlochmatrize	
square punch		square die		oblong punch		oblong die	
poinçon carré		matrice carrée		poinçon oblong		matrice oblongue	
Nr. 2		Nr. 3		Nr. 2		Nr. 3	
	Artikel-Nr.		Artikel-Nr.		Artikel-Nr.		Artikel-Nr.
4,0	64002 2040	4,2	64203 2042	5,0 × 10,0	64002 3 050100	5,2 × 10,2	64203 3 052102
5,0	64002 2050	5,2	64203 2052			5,7 × 10,7	64203 3 057107
6,0	64002 2060	6,2	64203 2062	5,0 × 14,0	64002 3 050140	5,2 × 14,2	64203 3 052142
7,0	64002 2070	6,7	64203 2067			5,7 × 14,7	64203 3 057147
8,0	64002 2080	7,2	64203 2072	5,5 × 10,0	64002 3 055100	5,7 × 10,2	64203 3 057102
9,0	64002 2090	7,7	64203 2077			6,2 × 10,7	64203 3 062107
10,0	64002 2100	8,2	64203 2082	5,5 × 14,0	64002 3 055140	5,7 × 14,2	64203 3 057142
11,0	64002 2110	8,7	64203 2087			6,2 × 14,7	64203 3 062147
12,0	64002 2120	9,2	64203 2092	5,5 × 19,0	64002 3 055190	5,7 × 19,2	64203 3 057192
13,0	64002 2130	9,7	64203 2097			6,2 × 19,7	64203 3 062197
		10,2	64203 2102	6,5 × 12,0	64002 3 065120	6,7 × 12,2	64203 3 067122
		10,7	64203 2107			7,2 × 12,7	64203 3 072127
		11,2	64203 2112	6,5 × 18,0	64002 3 065180	6,7 × 18,2	64203 3 067182
		11,7	64203 2117			7,2 × 18,7	64203 3 072187
		12,2	64203 2122	7,5 × 14,0	64002 3 075140	7,7 × 14,2	64203 3 077142
		12,7	64203 2127			8,2 × 14,7	64203 3 082147
		13,2	64203 2132	9,0 × 14,0	64002 3 090140	9,2 × 14,2	64203 3 092142
		13,7	64203 2137			9,7 × 14,7	64203 3 097147
		14,2	64203 2142	9,0 × 18,0	64002 3 090180	9,2 × 18,2	64203 3 092182
		14,7	64203 2147			9,7 × 18,7	64203 3 097187
		15,2	64203 2152	10,0 × 14,0	64002 3 100140	10,2 × 14,2	64203 3 102142
		15,7	64203 2157			10,7 × 14,7	64203 3 107147
		16,2	64203 2162			11,2 × 15,2	64203 3 112152
		16,7	64203 2167				
		17,2	64203 2172				
		17,7	64203 2177				
		18,2	64203 2182				
		18,7	64203 2187				
		19,2	64203 2192				
		19,7	64203 2197				
		20,2	64203 2202				
		20,7	64203 2207				
		21,2	64203 2212				
		21,7	64203 2217				
		22,2	64203 2222				
		22,7	64203 2227				
		23,2	64203 2232				
		23,7	64203 2237				

**Vierkantstempel**  
 square punch  
 poinçon carré

### Nr. 5

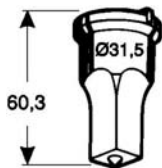

	Artikel-Nr.
14,0	64005 2140
15,0	64005 2150
16,0	64005 2160
17,0	64005 2170
18,0	64005 2180
19,0	64005 2190
20,0	64005 2200
21,0	64005 2210
22,0	64005 2220

Materialdicke	Schneidspiel	siehe Seite
material thickness	clearance	see page
épaisseur du matériau	jeu	voir page
bis 4 mm	0,2 mm	
4 – 9 mm	0,7 mm	71
9 – 14 mm	1,2 mm	

**Grüne Serie • Green Series • Série verte**

**Langlochstempel**  
 oblong punch  
 poinçon oblong

**Langlochmatrize**  
 oblong die  
 matrice oblongue

**Langlochstempel**  
 oblong punch  
 poinçon oblong

**Langlochmatrize**  
 oblong die  
 matrice oblongue

**Nr. 5**

**Nr. 3**

**Nr. 5**

**Nr. 3**

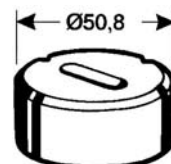
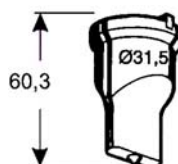
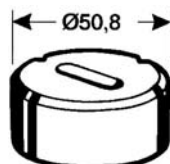
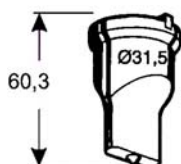

	Artikel-Nr.		Artikel-Nr.		Artikel-Nr.		Artikel-Nr.
<b>5,5 × 25,0</b>	64005 3 055250	<b>5,7 × 25,2</b>	64203 3 057252	<b>12,0 × 24,0</b>	64005 3 120240	<b>12,2 × 24,2</b>	64203 3 122242
		<b>6,2 × 25,7</b>	64203 3 062257			<b>12,7 × 24,7</b>	64203 3 127247
<b>6,5 × 26,0</b>	64005 3 065260	<b>6,7 × 26,2</b>	64203 3 067262	<b>12,0 × 30,0</b>	64005 3 120300	<b>13,2 × 25,2</b>	64203 3 132252
		<b>7,2 × 26,7</b>	64203 3 072267			<b>12,2 × 30,2</b>	64203 3 122302
<b>6,5 × 30,0</b>	64005 3 065300	<b>6,7 × 30,2</b>	64203 3 067302			<b>12,7 × 30,7</b>	64203 3 127307
		<b>7,2 × 30,7</b>	64203 3 072307	<b>13,0 × 26,0</b>	64005 3 130260	<b>13,2 × 31,2</b>	64203 3 132312
<b>7,5 × 21,0</b>	64005 3 075210	<b>7,7 × 21,2</b>	64203 3 077212			<b>13,2 × 26,2</b>	64203 3 132262
		<b>8,2 × 21,7</b>	64203 3 082217	<b>13,0 × 30,0</b>	64005 3 130300	<b>13,7 × 26,7</b>	64203 3 137267
<b>7,5 × 26,0</b>	64005 3 075260	<b>7,7 × 26,2</b>	64203 3 077262			<b>14,2 × 27,2</b>	64203 3 142272
		<b>8,2 × 26,7</b>	64203 3 082267	<b>13,0 × 26,0</b>	64005 3 130260	<b>13,2 × 30,2</b>	64203 3 132302
<b>7,5 × 30,0</b>	64005 3 075300	<b>7,7 × 30,2</b>	64203 3 077302			<b>13,7 × 30,7</b>	64203 3 137307
		<b>8,2 × 30,7</b>	64203 3 082307	<b>14,0 × 26,0</b>	64005 3 140260	<b>14,2 × 31,2</b>	64203 3 142312
<b>9,0 × 26,0</b>	64005 3 090260	<b>9,2 × 26,2</b>	64203 3 092262			<b>14,2 × 26,2</b>	64203 3 142262
		<b>9,7 × 26,7</b>	64203 3 097267	<b>14,0 × 28,0</b>	64005 3 140280	<b>14,7 × 26,7</b>	64203 3 147267
<b>9,0 × 30,0</b>	64005 3 090300	<b>9,2 × 30,2</b>	64203 3 092302			<b>15,2 × 27,2</b>	64203 3 152272
		<b>9,7 × 30,7</b>	64203 3 097307	<b>16,0 × 26,0</b>	64005 3 160260	<b>14,2 × 28,2</b>	64203 3 142282
<b>10,0 × 20,0</b>	64005 3 100200	<b>10,2 × 20,2</b>	64203 3 102202			<b>14,7 × 28,7</b>	64203 3 147287
		<b>10,7 × 20,7</b>	64203 3 107207	<b>16,0 × 26,0</b>	64005 3 160260	<b>15,2 × 29,2</b>	64203 3 152292
<b>10,0 × 26,0</b>	64005 3 100260	<b>11,2 × 21,2</b>	64203 3 112212			<b>16,2 × 26,2</b>	64203 3 162262
		<b>10,2 × 26,2</b>	64203 3 102262	<b>16,0 × 31,0</b>	64005 3 160310	<b>16,7 × 26,7</b>	64203 3 167267
<b>10,0 × 30,0</b>	64005 3 100300	<b>10,7 × 26,7</b>	64203 3 107267			<b>17,2 × 27,2</b>	64203 3 172272
		<b>11,2 × 27,2</b>	64203 3 112272	<b>18,0 × 26,0</b>	64005 3 180260	<b>16,2 × 31,2</b>	64203 3 162312
<b>11,0 × 22,0</b>	64005 3 110220	<b>10,2 × 30,2</b>	64203 3 102302			<b>16,7 × 31,7</b>	64203 3 167317
		<b>10,7 × 30,7</b>	64203 3 107307	<b>18,0 × 31,0</b>	64005 3 180310	<b>17,2 × 32,2</b>	64203 3 172322
<b>11,0 × 26,0</b>	64005 3 110260	<b>11,2 × 31,2</b>	64203 3 112312			<b>18,2 × 26,2</b>	64203 3 182262
		<b>11,2 × 22,2</b>	64203 3 112222	<b>18,0 × 26,0</b>	64005 3 180260	<b>18,7 × 26,7</b>	64203 3 187267
<b>11,0 × 30,0</b>	64005 3 110300	<b>11,7 × 22,7</b>	64203 3 117227			<b>19,2 × 27,2</b>	64203 3 192272
		<b>12,2 × 23,2</b>	64203 3 122232	<b>18,0 × 31,0</b>	64005 3 180310	<b>18,2 × 31,2</b>	64203 3 182312
<b>11,0 × 26,0</b>	64005 3 110260	<b>11,2 × 26,2</b>	64203 3 112262			<b>18,7 × 31,7</b>	64203 3 187317
		<b>11,7 × 26,7</b>	64203 3 117267	<b>20,0 × 31,0</b>	64005 3 200310	<b>19,2 × 32,2</b>	64203 3 192322
<b>11,0 × 30,0</b>	64005 3 110300	<b>12,2 × 27,2</b>	64203 3 122272			<b>20,2 × 31,2</b>	64203 3 202312
		<b>11,2 × 30,2</b>	64203 3 112302	<b>22,0 × 31,0</b>	64005 3 220310	<b>20,7 × 31,7</b>	64203 3 207317
		<b>11,7 × 30,7</b>	64203 3 117307			<b>21,2 × 32,2</b>	64203 3 212322
		<b>12,2 × 31,2</b>	64203 3 122312			<b>22,2 × 31,2</b>	64203 3 222312
						<b>22,7 × 31,7</b>	64203 3 227317
						<b>23,2 × 32,2</b>	64203 3 232322

Schneidpiel / clearance / jeu: **0,2 mm** (bis 4 mm Materialdicke) • **0,7 mm** (4 – 9 mm Materialdicke) • **1,2 mm** (9 – 14 mm Materialdicke)



## Grüne Serie • Green Series • Série verte

**Langlochstempel**  
 oblong punch  
 poinçon oblong

**Langlochstempel**  
 oblong punch  
 poinçon oblong

**Langloch-  
 Winkelstahlmatrize, längs**  
 oblong offset die, longitudinal  
 matrice oblongue décentrée,  
 sens longitudinal

**Langloch-  
 Winkelstahlmatrize, quer**  
 oblong offset die, transverse  
 matrice oblongue décentrée,  
 sens transversal

Nr. 2	Nr. 5	Nr. 14	Nr. 14
-------	-------	--------	--------

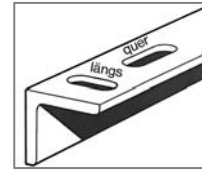
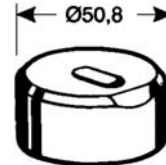
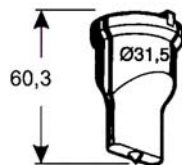
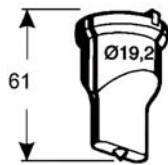

	Artikel-Nr.		Artikel-Nr.		Artikel-Nr.		Artikel-Nr.
<b>5,5 × 14,0</b>	64002 3 055140			<b>6,2 × 14,7</b>	64214 3 062147	<b>6,2 × 14,7</b>	64214 4 062147
		<b>5,5 × 25,0</b>	64005 3 055250	<b>6,2 × 25,7</b>	64214 3 062257	<b>6,2 × 25,7</b>	64214 4 062257
		<b>6,5 × 26,0</b>	64005 3 065260	<b>7,2 × 26,7</b>	64214 3 072267	<b>7,2 × 26,7</b>	64214 4 072267
		<b>7,5 × 26,0</b>	64005 3 075260	<b>8,2 × 26,7</b>	64214 3 082267	<b>8,2 × 26,7</b>	64214 4 082267
<b>9,0 × 14,0</b>	64002 3 090140			<b>9,7 × 14,7</b>	64214 3 097147	<b>9,7 × 14,7</b>	64214 4 097147
		<b>9,0 × 26,0</b>	64005 3 090260	<b>9,7 × 26,7</b>	64214 3 097267	<b>9,7 × 26,7</b>	64214 4 097267
		<b>10,0 × 20,0</b>	64005 3 100200	<b>10,7 × 20,7</b>	64214 3 107207	<b>10,7 × 20,7</b>	64214 4 107207
		<b>11,0 × 22,0</b>	64005 3 110220	<b>11,7 × 22,7</b>	64214 3 117227	<b>11,7 × 22,7</b>	64214 4 117227
		<b>11,0 × 26,0</b>	64005 3 110260	<b>11,7 × 26,7</b>	64214 3 117267	<b>11,7 × 26,7</b>	64214 4 117267
		<b>13,0 × 26,0</b>	64005 3 130260	<b>13,7 × 26,7</b>	64214 3 137267	<b>13,7 × 26,7</b>	64214 4 137267
		<b>14,0 × 26,0</b>	64005 3 140260	<b>14,7 × 26,7</b>	64214 3 147267	<b>14,7 × 26,7</b>	64214 4 147267
		<b>16,0 × 26,0</b>	64005 3 160260	<b>16,7 × 26,7</b>	64214 3 167267	<b>16,7 × 26,7</b>	64214 4 167267



Streichmaß bei Exzentermatrizen  
 back marks on offset dies  
 trusquinage, matrices décentrées

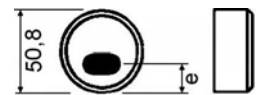

siehe Seite  
 see page  
 voir page  
 73

**Grüne Serie • Green Series • Série verte**

**Rechteckstempel**  
 rectangular punch  
 poinçon rectangulaire

**Rechteckmatrize**  
 rectangular die  
 matrice rectangulaire

**Schlüssellochstempel\***  
 key hole punch\*  
 poinçon pour canon européen\*

**Schlüssellochmatrize**  
 key hole die  
 matrice pour canon européen

**Nr. 5**

**Nr. 3**

**Nr. 5**

**Nr. 3**

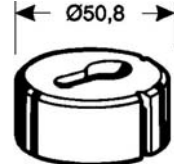
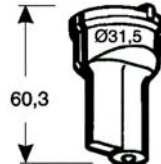
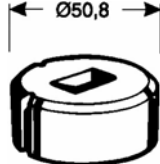
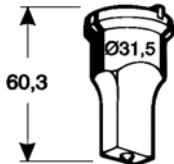

	Artikel-Nr.
5,0 × 15	64005 5 050150
5,0 × 20	64005 5 050200
6,0 × 24	64005 5 060240
8,0 × 16	64005 5 080160
8,0 × 24	64005 5 080240
9,0 × 24	64005 5 090240
10,0 × 20	64005 5 100200
11,0 × 22	64005 5 110220
12,0 × 22	64005 5 120220
12,0 × 30	64005 5 120300
14,0 × 20	64005 5 140200
16,0 × 20	64005 5 160200

	Artikel-Nr.
5,2 × 15,2	64203 5 052152
5,7 × 15,7	64203 5 057157
5,2 × 20,2	64203 5 052202
5,7 × 20,7	64203 5 057207
6,2 × 24,2	64203 5 062242
6,7 × 24,7	64203 5 067247
8,2 × 16,2	64203 5 082162
8,7 × 16,7	64203 5 087167
8,2 × 24,2	64203 5 082242
8,7 × 24,7	64203 5 087247
9,2 × 24,2	64203 5 092242
9,7 × 24,7	64203 5 097247
10,2 × 20,2	64203 5 102202
10,7 × 20,7	64203 5 107207
11,2 × 22,2	64203 5 112222
11,7 × 22,7	64203 5 117227
12,2 × 22,2	64203 5 122222
12,7 × 22,7	64203 5 127227
12,2 × 30,2	64203 5 122302
12,7 × 30,7	64203 5 127307
14,2 × 20,2	64203 5 142202
14,7 × 20,7	64203 5 147207
16,2 × 20,2	64203 5 162202
16,7 × 20,7	64203 5 167207

	Artikel-Nr.
<b>34,0 × Ø17,5 × 10,5</b>	65005 17001

\*zusätzlich erforderlich :  
 \*additionally required • nécessaire en plus:

für Stempel-Schnellwechsellvorrichtung  
 – grüne Serie – ab 1993  
 for quick-change punching attachments  
 – green series – supplied since 1993  
 pour dispositifs de serrage rapide,  
 – série verte – fournis depuis 1993

**Schnellspanneinsatz Schlüsselloch**  
 quick-change punch sleeve, keyhole  
 douille de serrage rapide, canon européen

vor • prior to • avant • 1993:  
**Schnellspanneinsatz Schlüsselloch**  
 quick-change punch sleeve, keyhole  
 douille de serrage rapide, canon européen

	Artikel-Nr.
<b>34,2 × Ø17,7 × 10,7</b>	65203 17001

42217 6 2002 02

P-44081 6 2005 01

**Eckenabrundstempel**  
 corner radiusing punch  
 poinçon p. arrondir les angles

**Eckenabrundmatrize**  
 corner radiusing die  
 matrice p. arrondir les angles

**Drehriegelstempel**  
 hasp hole punch  
 poinçon trou d'espagnolette

**Drehriegelmatrize**  
 hasp hole die  
 matrice trou d'espagnolette

**Nr. 5**

**Nr. 3**

**Nr. 5**

**Nr. 3**

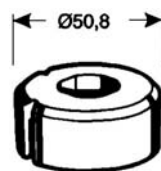
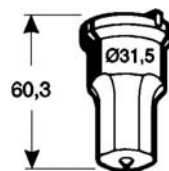
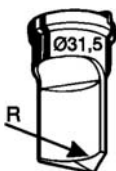

Radius	Artikel-Nr.
5	65005 37 00050
10	65005 37 00100
15	65005 37 00150

Radius	Artikel-Nr.
5	65203 37 00050
10	65203 37 00100
14	65203 37 00140
15	65203 37 00150

	Artikel-Nr.
<b>Ø 22,2 × 20,3</b>	65005 38 222203

	Artikel-Nr.
<b>Ø 22,4 × 20,5</b>	65203 38 224205

## Grüne Serie • Green Series • Série verte

### Spezial-Stempel zum Stanzen von VA-Material Special Punches for Punching Stainless Steel Poinçons spéciaux pour poinçonner du matériau inox

**Spezial-Rundstempel**  
**special round punch**  
**poinçon rond spécial**

Rundmatrize (Standard)  
 round die (standard)  
 matrice ronde (standard)

Rundmatrize (Standard)  
 round die (standard)  
 matrice ronde (standard)

**Spezial-Vierkantstempel**  
**special square punch**  
**poinçon carré spécial**

**Nr. 2**

**Nr. 3**

**Nr. 3**

**Nr. 2**

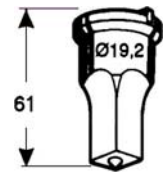
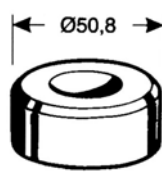
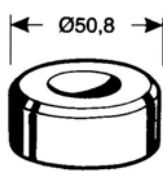
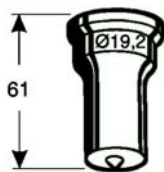

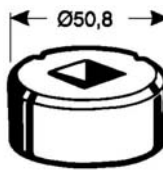
Artikel-Nr.	Artikel-Nr.	Artikel-Nr.	Artikel-Nr.
<b>3,0</b> P-65002 8012 030	<b>3,2</b> 64203 1032	<b>12,2</b> 64203 1122	<b>9,0</b> P-65002 8014 090  Vierkantmatrize (Standard) square die (standard) matrice carrée (standard)
<b>4,0</b> P-65002 8012 040	<b>3,7</b> 64203 1037	<b>12,7</b> 64203 1127	
<b>4,5</b> P-65002 8012 045	<b>4,2</b> 64203 1042	<b>13,2</b> 64203 1132	
<b>5,0</b> P-65002 8012 050	<b>4,7</b> 64203 1047	<b>13,7</b> 64203 1137	
<b>5,5</b> P-65002 8012 055	<b>5,2</b> 64203 1052	<b>14,2</b> 64203 1142	
<b>6,0</b> P-65002 8012 060	<b>5,7</b> 64203 1057	<b>14,7</b> 64203 1147	
<b>6,5</b> P-65002 8012 065	<b>6,2</b> 64203 1062	<b>15,2</b> 64203 1152	
<b>7,0</b> P-65002 8012 070	<b>6,7</b> 64203 1067	<b>15,7</b> 64203 1157	
<b>8,0</b> P-65002 8012 080	<b>7,2</b> 64203 1072	<b>16,2</b> 64203 1162	
<b>9,0</b> P-65002 8012 090	<b>7,7</b> 64203 1077	<b>16,7</b> 64203 1167	
<b>10,0</b> P-65002 8012 100	<b>8,2</b> 64203 1082	<b>17,2</b> 64203 1172	
<b>11,0</b> P-65002 8012 110	<b>8,7</b> 64203 1087	<b>17,7</b> 64203 1177	
<b>12,0</b> P-65002 8012 120	<b>9,2</b> 64203 1092	<b>18,2</b> 64203 1182	
<b>13,0</b> P-65002 8012 130	<b>9,7</b> 64203 1097		
<b>14,0</b> P-65002 8012 140	<b>10,2</b> 64203 1102		
<b>15,0</b> P-65002 8012 150	<b>10,7</b> 64203 1107		
<b>16,0</b> P-65002 8012 160	<b>11,2</b> 64203 1112		
<b>17,0</b> P-65002 8012 170	<b>11,7</b> 64203 1117		
			<b>Nr. 3</b>
			
			Artikel-Nr.
			<b>9,7</b> 64203 2097

**Spezial-Langlochstempel**  
**special oblong punch**  
**poinçon oblong spécial**

Langlochmatrize (Standard)  
 oblong die (standard)  
 matrice oblongue (standard)

**Spezial-Langlochstempel**  
**special oblong punch**  
**poinçon oblong spécial**

Langlochmatrize (Standard)  
 oblong die (standard)  
 matrice oblongue (standard)

**Nr. 2**

**Nr. 3**

**Nr. 5**

**Nr. 3**

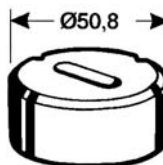
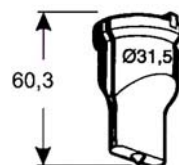
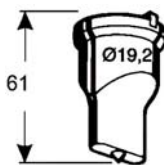

Artikel-Nr.	Artikel-Nr.	Artikel-Nr.	Artikel-Nr.
<b>9,0 × 14,0</b> P-65002 8013 01	<b>9,7 × 14,7</b> 64203 3 097147	<b>10,0 × 30,0</b> P-65005 8024 01	<b>10,7 × 30,7</b> 64203 3 107307
<b>9,0 × 18,0</b> P-65002 8013 03	<b>9,7 × 18,7</b> 64203 3 097187		<b>11,2 × 31,2</b> 64203 3 112312
		<b>11,0 × 26,0</b> P-65005 8024 04	<b>11,7 × 26,7</b> 64203 3 117267
			<b>12,2 × 27,2</b> 64203 3 122272
		<b>11,0 × 30,0</b> P-65005 8024 03	<b>11,7 × 30,7</b> 64203 3 117307
			<b>12,2 × 31,2</b> 64203 3 122312